

INNOVATION LIVING™

The Danish sofa bed specialist established in 1971



Expand Your
Living Space
In Style



Plant trees

We contribute to the balance of the global ecosystem by planting more than 10.000 trees every year to compensate for our consumption of wood.



Prioritizing recycled materials

We thoughtfully select all materials, considering their overall quality and the sustainability profile of the product.



Detachable covers

A growing part of our collection comes with detachable and washable covers.



FSC®-certified

Our production facilities are FSC®-certified.



Optimized for transport

Our designs and packaging are optimized to ensure minimized CO₂ emissions in relation to transport and storage.



Design for disassembly

Our design strategy allows for easy replacement of components to prolong a product's life cycle.



OEKO-TEX® fabrics

Our fabrics are OEKO-TEX® certified. OEKO-TEX® is one of the world's best-known labels for textiles tested for harmful substances to ensure customer confidence and high product safety.



5 YEAR

Warranty

We offer a 5 year warranty on all designs and a lifetime warranty on slats and gears for all sofa beds in our Multifunctionals category.

About

Innovation Living™ is a Danish sofa bed specialist built on the proud Danish tradition of furniture design. We believe that form and function must go hand in hand to create innovative, durable designs for everyday use. Since 1971 we have dedicated ourselves to the design and development of multifunctional sofa beds, and today we are proud to be able to call Innovation Living™ an internationally renowned sofa bed specialist.

Comfort

Comfort is always at the center of our design process

A design's aesthetic expression will, to some extent, be decisive for the product's comfort. The elegant slim design will quite naturally tend to be firmer than the large bulky design.

Our design process centers around comfort, as we aim to deliver the best possible comfort with each design.



The Patchwork Project	8
Designed for Longevity	12
Environmental Considerations	14
The Soft Touch	16
The Scandinavian Touch	44
European Modernism	82
Mid-Century Modern	126
Designers	148
Chairs & Floorlife	150-152
Cushions & Headrest	153
Coffee Tables	154-155
Comfort	156-161
Fabric Specifications & Fabrics	162-163

Index

Index by product name

Aslak	72	Narvi	122
Balder	64	Newilla	20
Bifrost D.E.L.	124	Newilla with lounger	22
Bragi	116	Nolis	58
Cassius D.E.L.	98	Nordham	102
Colpus	146	Olan	38
Conlix	142	Osvald	28
Conlix Patchwork	10	Pascala	34
Cornila	30	Puri	12
Cosial	24-27	Pyxis D.E.L.	70
Cubed Alu	86	Recast Dark Styletto	138
Cubed Chrome	88	Recast Light Styletto	140
Cubed with arms	90	Rollo	66
Cubed Wood	56	Sigga X	114
Dublexo Dark Styletto with arms	134	Sigmund Drip	68
Dublexo Eik Oak	51	Sigmund Indu	112
Dublexo Frej & Eik Oak	48	Sly	118
Dublexo Stem	53	Sly Wood	74
Eilis	54	Splitback Chrome with arms	84
Eivor	40	Splitback Dark Styletto with arms	132
Eluma Deluxe Button	62	Splitback Eik Smoked Oak	50
Fraction	120	Splitback Frej & Eik Smoked Oak	46
Frode & Frode with arms	80	Splitback Stem	52
Ghia Chrome	94	Supremax D.E.L.	96
Ghia Laser	95	Tripi	30
Ghia Wood	67	Trym	75
Idun	76	Unfurl	130
Junus	110	Unfurl Lounger	128
Killian	42	Unfurl Special Teddy	131
Long Horn D.E.L.	104	Vanadis	144
Luoma	106	Vikko	150
Malloy	108	Vogan	32
Malloy Wood	60	Vogan Lounger	32
Merga	36	Yonata	18
Mimer	78	Zeal Laser	93
Minimum	100	Zeal Straw	92
Multifunctionals Patchwork	11	Zeal Styletto	136

Much more information about each design online

Scan the QR code at the bottom of each page to access our visualizer and view the full product presentation.

View the sofa from all angles in your favorite fabric

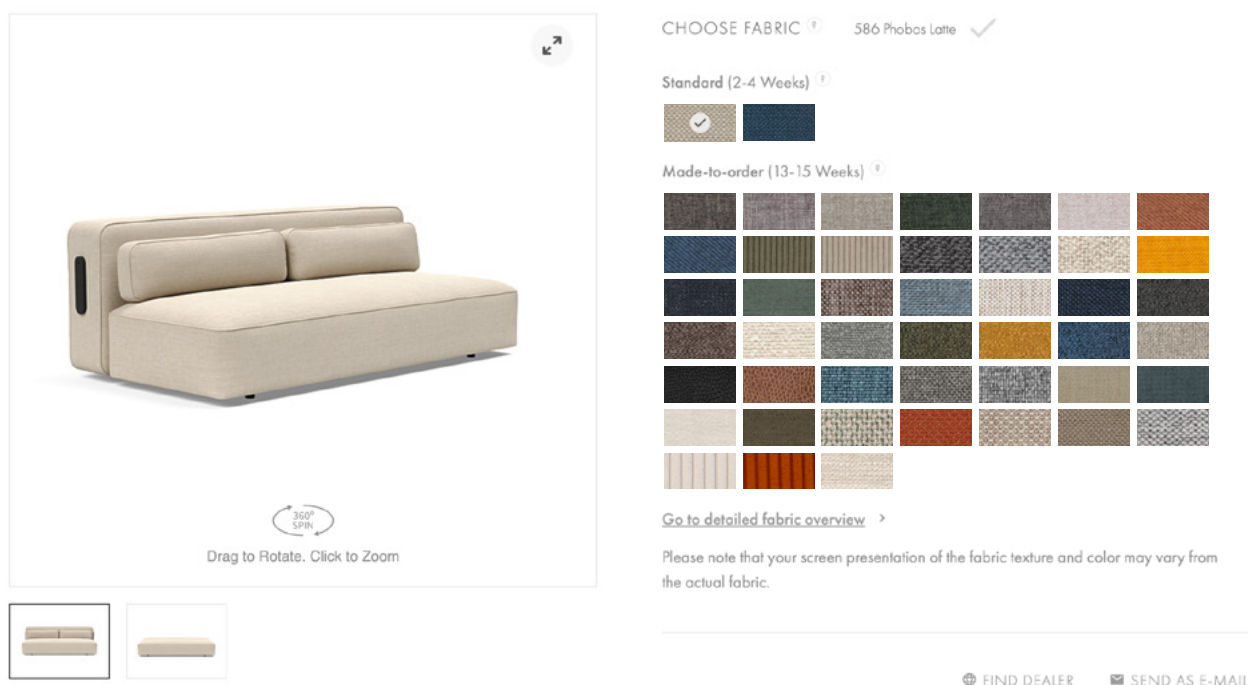

CHOOSE FABRIC [?] 586 Phobos Latte ✓

Standard (2-4 Weeks) [?]

Made-to-order (13-15 Weeks) [?]

Go to detailed fabric overview [>]

Please note that your screen presentation of the fabric texture and color may vary from the actual fabric.

FIND DEALER SEND AS E-MAIL

- Find detailed information about each product
- Evaluate the product from all angles in the visualizer
- View a video demonstration of the functionality of the product
- View the product in your favorite fabric



The Patchwork Project



Revitalizing excess fabrics

The Patchwork Project is a collection of limited edition striped patchwork covers made from excess fabrics.

Each textile combination has a limited number of covers based on remaining stock of textile. Please visit our website to see the available covers.

The covers are detachable, washable, and interchangeable with any standard cover for Conlix or any Multifunctionals when worn, or if times call for a more understated cover.

The Patchwork Project

Conlix Patchwork

Design by Per Weiss 2022

Bed size 140 x 200 cm | Metal frame with Pocket Spring comfort, see page 156 | Trumpet legs in black lacquered oak | Detachable and washable covers made of excess fabrics | Bedding box | Shown in Patchwork Blue, Red and Green cover | Shown Patchwork covers: 2-4 weeks delivery time | The Patchwork covers are only available for Conlix | Scan the QR code to see additional features at our website

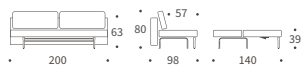

Multifunctionals Patchwork

Design by Per Weiss 2022

Bed size 140 x 200 cm | Metal frame with beech wood slats | Available for all Multifunctional comforts, see page 160 | Back frame cover included | Optional seat frame cover | Bedding box | Detachable and washable covers and frame covers made of excess fabrics | Shown combination: Fraction 140 frame, Soft Spring mattress and Patchwork Green, Blue and Red cover | Shown Patchwork covers: 2-4 weeks delivery time | The Patchwork covers are only available for Aslak 140, Balder, Colpus, Fraction 140, Minimum and Junus | Scan the QR code to see additional features at our website

Multifunctionals Patchwork is part of the Multifunctionals assortment and has several options of mattress comfort and cover styles, see page 160-161



Designed for Longevity

Puri

Designed for Longevity

Design by Per Weiss 2021

Puri is our take on a design where every detail and material has been carefully evaluated and prioritized with sustainability in mind.

Puri has been designed for maintenance and long life cycle. The frame is made of a durable metal construction, and the covers are detachable, washable, and renewable. The OEKO-TEX® high resilient foam filling of the seats and cushion can also be replaced over time. Puri is designed for disassembly and recycling, and is flat packed to minimize transportation volume. The recommended fabrics are made from recycled fibers.

Bed size 80 x 195 cm | Matt black metal frame with a mattress made of OEKO-TEX® high resilient foam, see page 158 | One back cushion included | Table top in lacquered oak or lacquered walnut | Detachable and washable covers | Shown in 536 Bouclé Ochre | Shown fabrics: 2-4 weeks delivery time | Other fabric options with 6-8 weeks delivery time, see page 163 | Scan the QR code to see additional features at our website



535

536

537

584



Oak table



Walnut table





Environmental Considerations

Give back to nature

To contribute to the balance of the global ecosystem, Innovation Living plants more than 10.000 new trees every year to compensate for our consumption of wood.

Detachable covers

As it offer obvious benefits, a growing part of our collection comes with detachable and washable covers. The sofa is easy to maintain as covers can be machine washed at 30 degrees Celsius. Upholstery can be replaced if it is worn out, or if you want to freshen up your sofa. Instead of replacing the entire sofa, this will create a significantly smaller impact on the environment.

Products available with detachable covers:

Aslak, Balder, Colpus, Conlix, Conlix Patchwork, Fraction, Idun, Junus, Merga, Mimer, Minimum, Multifunctionals Patchwork, Narvi, Newilla, Newilla with lounger, Pascala, Pauke, Puri, Rollo, Soft Peak, Triangular, Trym and Yonata.

Look for this icon:



Fabrics

As not all designs are suitable for removable covers, the durability of the fabric and ease of cleaning become crucial for the longevity of each design. All fabrics are highly durable and upgraded by adding backsides to strengthen them even further. All fabrics can withstand washing at 30 degrees Celsius, which means that products can withstand wet cleaning. Finally, all our fabrics are OEKO-TEX® Standard 100 certified, signifying that they are free of harmful substances.

Recycled fabrics

The supply of fabrics made from recycled fibers is fortunately constantly increasing. More than 1/3 of our quality fabrics are made from recycled polyester which can for instance be recycled plastic bottles. Please look for Bouclé, Vivus and Argus fabrics - see page 163.

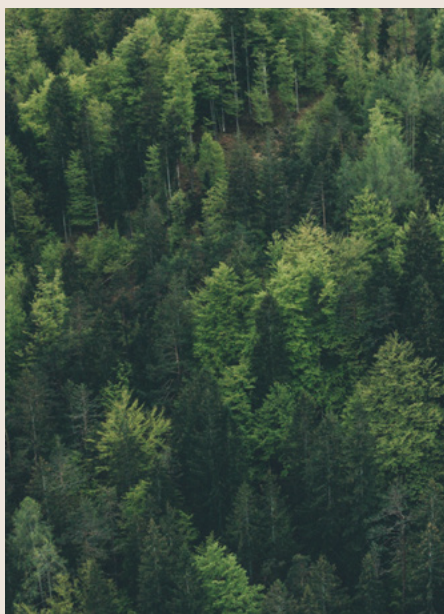

Lower CO₂ footprint

Since 1989, all our products have been designed for flat packing, which minimizes CO₂ emissions during transportation and storage. We continuously work to reduce the environmental impact of our activities, and you can read more about our specific initiatives on our website. Although we are not CO₂ neutral, we are committed to minimizing our CO₂ footprint.

Maintain and refresh

Designing for flat packing means creating a set of parts that easily combine into a full product. The complexity and number of parts vary from product to product, but the design strategy allows for easy replacement of components to prolong a product's life cycle - whether it is to replace a worn-out part or refresh product's appearance.

Disassembly and recycling

In our design process, we focus on the ability to disassemble our products and materials after their life cycle ends. We carefully consider which materials to use, how to combine them, and how to separate them into individual parts for recycling. Each design presents a unique challenge, and some are more suitable for disassembly than others, but the ECO-dimension is always an integral part of our design philosophy.

Durability | 5 years warranty

Quality and durability are at the center of our design and production process. We offer a 5 year warranty on all designs and a lifetime warranty on slats and gears for all sofa beds in our Multifunctionals category. For further information about our warranty, please visit our website.

Certified production facilities

We engage in the development of local communities to contribute to a better tomorrow in the areas we operate in. To ensure ongoing improvement, our production facilities undergo continuous audits to confirm that our group values and working conditions are upheld, as outlined by third-party standards such as the amfori BSCI Code of Conduct. In addition our production units are also FSC®-certified.

For more information about our standards and principles, please visit our website.

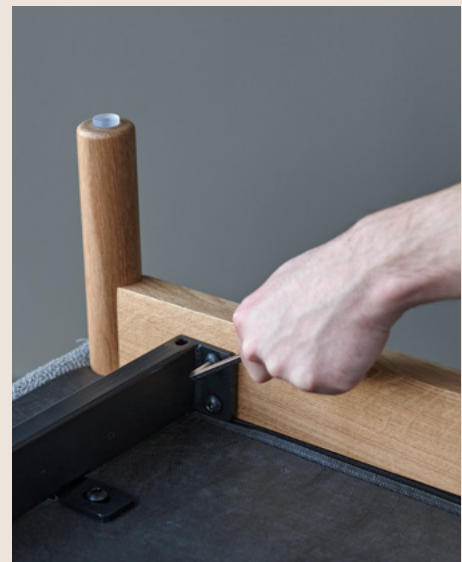

amfori  BSCI
Trade with purpose



The mark of
responsible forestry
FSC® C174105

The Soft Touch



The Soft Touch

A selection of minimalist designs with a soft and voluminous character.

The Soft Touch



Yonata

Design by Emil Højfeldt & Per Weiss 2021

Bed size 145 x 200 cm | Metal frame with Excess Pocket Spring comfort, see page 156 | Legs in matt black aluminum | Detachable and washable covers | Shown in 586 Phobos Latte | Shown fabrics: 2-4 weeks delivery time | Other fabric options with 13-15 weeks delivery time, see page 163 | Scan the QR code to see additional features at our website

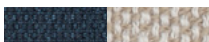

580

586

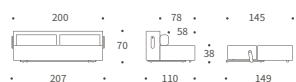

The Soft Touch

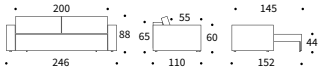

Newilla

Design by Per Weiss 2022

Bed size 145 x 200 cm | No-zag and Pocket Spring comfort with hyper soft foam, see page 157 | Integrated storage | Detachable and washable covers | Optional headrest | Page 20: Shown in 594 Corduroy Ivory | Page 21: Shown in 357 Taura Off White | Shown fabrics: 2-4 weeks delivery time | Other fabric options with 6-8 weeks delivery time, see page 163 | Scan the QR code to see additional features at our website



The Soft Touch



Newilla with lounger

Design by Per Weiss 2022

Bed size 145 x 300 cm | No-zag and Pocket Spring comfort with hyper soft foam, see page 157 | Integrated storage | Lounger is Left/right reversible | Detachable and washable covers | Optional headrest | Shown in 530 Bouclé Taupe | Shown fabrics: 2-4 weeks delivery time | Other fabric options with 6-8 weeks delivery time, see page 163 | Scan the QR code to see additional features at our website

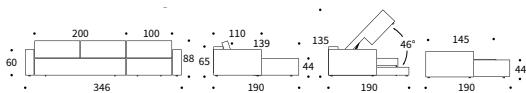

The Soft Touch



Cosial

Design by Per Weiss 2021

Bed sizes 80 x 195 cm, 140 x 195 cm, 160 x 195 cm and 180 x 195 cm | Metal frame with Pocket Spring comfort, see page 156 | Optional headrest | Shown in size 180 cm in 586 Phobos Latte | Shown fabrics: 2-4 weeks delivery time | Other fabric options with 13-15 weeks delivery time, see page 163 | Scan the QR code to see additional features at our website

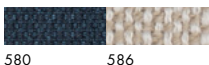
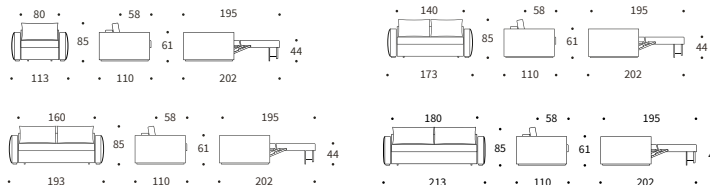

The Soft Touch

Cosial

Design by Per Weiss 2021

Bed sizes 80 x 195 cm, 140 x 195 cm, 160 x 195 cm and 180 x 195 cm | Metal frame with Pocket Spring comfort, see page 156 | Optional headrest | Page 26: Shown in 80, 140, 160, 180 cm in 586 Phobos Latte | Page 27: Shown in 80 cm in 580 Argus Navy Blue | Shown fabrics: 2-4 weeks delivery time | Other fabric options with 13-15 weeks delivery time, see page 163 | Scan the QR code to see additional features at our website

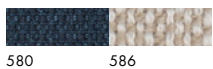
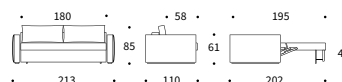
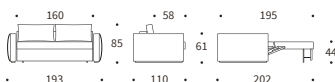
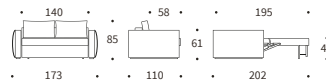
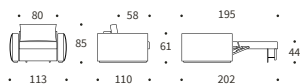



The Soft Touch

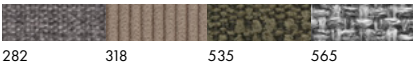
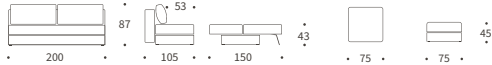

Osvald

Design by Emil Højfeldt & Per Weiss 2015, 2018

Bed size 150 x 200 cm | Cornila ottoman size 75 x 75 cm | Metal frame with Pocket Spring Dual comfort, see page 156 | Integrated storage in sofa bed and ottoman | Optional headrest | Page 28: Shown in 535 Bouclé Forest Green | Page 29: Shown in 282 Avella Warm Grey | Shown fabrics: 2-4 weeks delivery time | Other fabric options with 6-8 weeks delivery time, see page 163 | Scan the QR code to see additional features at our website



The Soft Touch



Tripi & Cornila

Design by Emil Højfeldt & Per Weiss 2015, 2016, 2018

Bed size 150 x 200 cm | Cornila ottoman size 75 x 75 cm | Metal frame with Pocket Spring Dual comfort, see page 156 | Integrated storage in sofa bed and ottoman | Optional headrest | Page 30: Tripi and Cornila shown in 565 Twist Granite | Page 31: Tripi and Cornila shown in 318 Cordufine Beige | Shown fabrics: 2-4 weeks delivery time | Other fabric options with 6-8 weeks delivery time, see page 163 | Scan the QR code to see additional features at our website

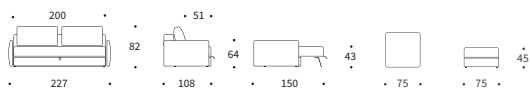

The Soft Touch

Vogan & Vogan Lounger

Design by Oliver & Lukas WeissKrogh 2017, 2019

Bed size 120 x 200 cm | 80 cm seat module available in 2 depths, 120 cm or 160 cm | Metal frame with Excess Pocket Spring comfort, see page 156 | Back shelf in black lacquered oak | Shown in 539 Bouclé Beige | Shown fabric: 2-4 weeks delivery time | Other fabric options with 13-15 weeks delivery time, see page 163 | Scan the QR code to see additional features at our website



539

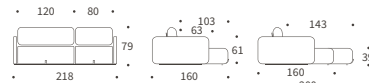
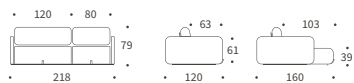



The Soft Touch



Pascala

Design by Per Weiss 2021

Bed size 140 x 200 cm | Metal frame with Pocket Spring comfort, see page 156 | Detachable and washable covers | Bedding box | Shown in 574 Vivus Off White | Shown fabrics: 2-4 weeks delivery time | Other fabric options with 6-8 weeks delivery time, see page 163 | Scan the QR code to see additional features at our website



The Soft Touch



Merga

Design by Emil Højfeldt & Per Weiss 2020

Bed size 140 x 200 cm | No-zag and Pocket Spring comfort with hyper soft foam, see page 157 | Legs in black lacquered oak | Detachable and washable covers | Integrated storage | Shown in 536 Bouclé Ochre | Optional headrest | Shown fabrics: 2-4 weeks delivery time | Other fabric options with 6-8 weeks delivery time, see page 163 | Scan the QR code to see additional features at our website

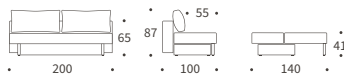

The Soft Touch

Olan

Design by Per Weiss 2017

Bed size 140 x 195 cm | No-zag Spring with high resilient foam comfort, see pages 156 | Shown in 565 Twist Granite | Optional headrest | Shown fabric: 2-4 weeks delivery time | Other fabric options with 6-8 weeks delivery time, see page 163 | Scan the QR code to see additional features at our website



565





The Soft Touch



Eivor

Design by Per Weiss 2017

Bed sizes 140 x 195 cm and 160 x 195 cm | Metal frame with 5-zone Multi-Pocket Spring or Dual Memory mattress, see page 158 | Shown in size 140 cm in 565 Twist Granite | Shown fabrics: 2-4 weeks delivery time | Other fabric options with 6-8 weeks delivery time, see page 163 | Scan the QR code to see additional features at our website



539

565



The Soft Touch



Killian

Design by Per Weiss 2019

Bed sizes 140 x 195 cm and 160 x 195 cm | Metal frame with 5-zone Multi-Pocket Spring or Dual Memory mattress, see page 158 | Shown in size 160 cm in 539 Bouclé Beige | Shown fabrics: 2-4 weeks delivery time | Other fabric options with 6-8 weeks delivery time, see page 163 | Scan the QR code to see additional features at our website

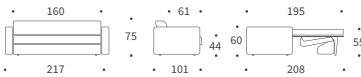
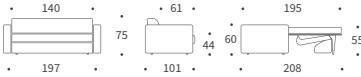
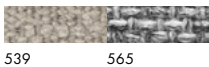

The Scandinavian Touch



The Scandinavian Touch

A range characterized by carefully crafted signature wood details designed with reference to the internationally acclaimed Scandinavian interpretation of early European modernism.

The Scandinavian Touch

Splitback Frej & Eik Smoked Oak

Design by Per Weiss, Oliver & Lukas WeissKrogh 2004, 2015

Bed size 115 x 210 cm | Chair size 115 x 90 cm | Metal frame with Pocket Spring comfort, see page 156 |
Legs shown in smoked oak | Shown in 580 Argus Navy Blue | Shown fabrics: 2-4 weeks delivery time |
Other fabric options with 13-15 weeks delivery time, see page 163 | Scan the QR code to see additional
features at our website



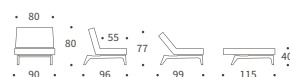
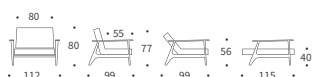

The Scandinavian Touch

Dublexo Frej & Eik Oak

Design by Per Weiss, Oliver & Lukas WeissKrogh 2011, 2015

Bed size 115 x 210 cm | Chair size 115 x 90 cm | Metal frame with Pocket Spring Dual comfort, see page 156 | Legs shown in lacquered oak | Shown in 527 Mixed Dance Natural | Shown fabrics: 2-4 weeks delivery time | Other fabric options with 13-15 weeks delivery time, see page 163 | Scan the QR code to see additional features at our website



527

558

563

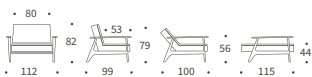
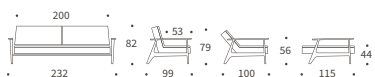

The Scandinavian Touch

Splitback Eik Smoked Oak

Design by Per Weiss, Oliver & Lukas WeissKrogh 2004, 2015

Bed size 115 x 210 cm | Chair size 115 x 90 cm | Metal frame with Pocket Spring comfort, see page 156 | Legs shown in smoked oak | Shown in 507 Elegance Burned Curry | Shown fabrics: 2-4 weeks delivery time | Other fabric options with 13-15 weeks delivery time, see page 163 | Scan the QR code to see additional features at our website

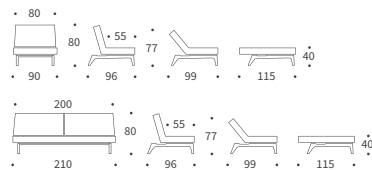

Dublexo Eik Oak

Design by Per Weiss, Oliver & Lukas WeissKrogh 2011, 2015

Bed size 115 x 210 cm | Chair size 115 x 90 cm | Metal frame with Pocket Spring Dual comfort, see page 156 | Legs shown in lacquered oak | Shown in 558 Soft Indigo | Shown fabrics: 2-4 weeks delivery time | Other fabric options with 13-15 weeks delivery time, see page 163 | Scan the QR code to see additional features at our website

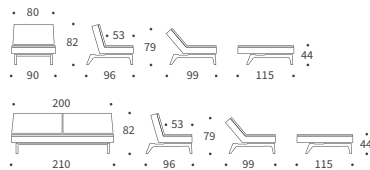
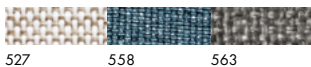

The Scandinavian Touch

Splitback Stem

Design by Per Weiss 2004, 2015

Bed size 115 x 210 cm | Chair size 115 x 90 cm | Metal frame with Pocket Spring comfort, see page 156 |
Legs in lacquered oak | Shown in 525 Mixed Dance Light Blue | Shown fabrics: 2-4 weeks delivery time |
Other fabric options with 13-15 weeks delivery time, see page 163 | Scan the QR code to see additional
features at our website

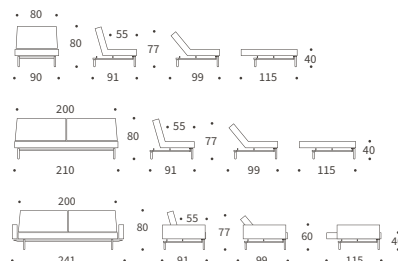

Dublexo Stem

Design by Per Weiss 2011

Bed size 115 x 210 cm | Chair size 115 x 90 cm | Metal frame with Pocket Spring Dual comfort, see page 156 | Legs in lacquered oak | Shown in 527 Mixed Dance Natural | Shown fabrics: 2-4 weeks delivery time | Other fabric options with 13-15 weeks delivery time, see page 163 | Scan the QR code to see additional features at our website

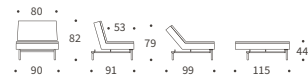
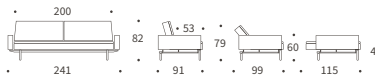

The Scandinavian Touch

Eilis

Design by Per Weiss 2023

Bed size 140 x 200 cm | Metal frame with Pocket Spring comfort, see page 156 | Legs in dark lacquered oak | Bedding box | Optional headrest | Shown in 280 Avella Sand | Only available in the shown fabric: 2-4 weeks delivery time | Scan the QR code to see additional features at our website



280





The Scandinavian Touch

Cubed Wood

Design by Per Weiss, Oliver & Lukas WeissKrogh 2009, 2015

Bed sizes 90 x 200 cm, 140 x 200 cm and 160 x 200 cm | No-zag Spring with high resilient foam comfort, see page 156 | Legs in lacquered oak | Bedding box | Optional headrest | Shown in size 140 cm in 565 Twist Granite | Shown fabrics: 2-4 weeks delivery time | Other fabric options with 6-8 weeks delivery time, see page 163 | Scan the QR code to see additional features at our website

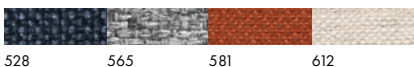
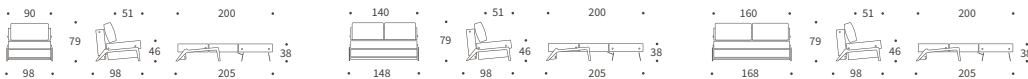



The Scandinavian Touch



Nolis

Design by Oliver & Lukas WeissKrogh 2022

Bed size 90 x 200 cm | Metal frame with Pocket Spring comfort, see page 156 | Legs in lacquered oak | Shown in 539 Bouclé Beige | Shown fabric: 2-4 weeks delivery time | Other fabric options with 13-15 weeks delivery time, see page 163 | Scan the QR code to see additional features at our website



539



The Scandinavian Touch



Malloy Wood

Design by Per Weiss, Oliver & Lukas WeissKrogh 2020, 2021

Bed size 150 x 200 cm | Ottoman size 75 x 100 cm | Metal frame with Pocket Spring Dual comfort, see page 156 | Arms and legs in lacquered oak | Bedding box | Shown in 533 Bouclé Ash Grey | Shown fabrics: 2-4 weeks delivery time | Other fabric options with 13-15 weeks delivery time, see page 163 | Scan the QR code to see additional features at our website



533

579





Eluma Deluxe Button

Design by Per Weiss, Oliver & Lukas WeissKrogh 2016

Bed size 140 x 200 cm | Metal frame with Pocket Spring comfort, see page 156 | Arms and legs in lacquered oak | Bedding box | Optional headrest | Shown in 565 Twist Granite | Shown fabric: 2-4 weeks delivery time | Other fabric options with 13-15 weeks delivery time, see page 163 | Scan the QR code to see additional features at our website



565

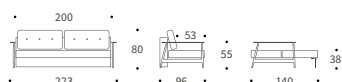

The Scandinavian Touch



Balder

Design by Per Weiss, Oliver & Lukas WeissKrogh 2015

Bed size 140 x 200 cm | Metal frame with beech wood slats | Soft Spring comfort with detachable Nordic cover, see page 160 | Arms and legs in lacquered oak | Back frame cover included | Optional seat frame cover | Bedding box | Detachable and washable covers | Shown in 539 Bouclé Beige | 2-4 weeks delivery time | See all fabric options, page 163 | Scan the QR code to see additional features at our website

Balder is part of the Multifunctionals assortment and has several options of mattress comfort and cover styles, see page 160-161



The Scandinavian Touch

Rollo

Design by Flemming Højfeldt & Per Weiss 1993

Bed size 80 x 200 cm | Metal frame with Classic or Pocket Spring comfort, see page 160 | See leg options below | Detachable mattress and washable frame covers | Optional: Detachable mattress cover, frame cover and cushions | Shown in lacquered oak | Shown in 537 Bouclé Blue | 2-4 weeks delivery time | See all fabric options, page 163 | Available in all fabrics, see page 163 | Scan the QR code to see additional features at our website

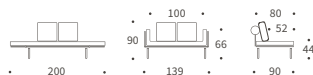

Bow legs in lacquered oak



Stem legs in lacquered oak



Styletto legs in dark lacquered oak



Ghia Wood

Design by Per Weiss 2007, 2015

Bed size 80 x 210 cm | Metal frame with Pocket Spring comfort, see page 156 | Legs in lacquered oak |
 Shown in 318 Cordufine Beige | Shown fabrics: 2-4 weeks delivery time | Other fabric options with
 13-15 weeks delivery time, see page 163 | Scan the QR code to see additional features at our website

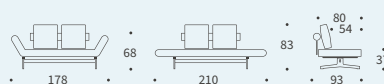

Minimalist multifunctional daybed and playground



Sigmund Drip

Design by Per Weiss 2016

Bed sizes 80 / 160 x 200 cm | Pocket Spring comfort, see page 157 | Drip legs in lacquered oak |
 Shown in 579 Kenya Gravel | Shown fabrics: 2-4 weeks delivery time | Other fabric options with 6-8
 weeks delivery time, see page 163 | Scan the QR code to see additional features at our website

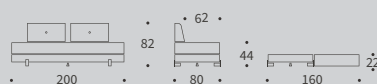

The Scandinavian Touch



Pyxis D.E.L.

Design by Per Weiss 2008, 2021

Bed size 155 x 200 cm | Ottoman size 65 x 65 cm | Metal frame with Excess Pocket Spring comfort, see page 156 | Legs in lacquered oak | Optional headrest | Shown in 587 Phobos Mocha | Shown fabrics: 2-4 weeks delivery time | Other fabric options with 13-15 weeks delivery time, see page 163 | Scan the QR code to see additional features at our website



528 563 587

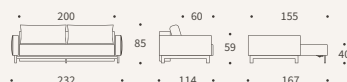

The Scandinavian Touch



Aslak

Design by Per Weiss, Oliver & Lukas WeissKrogh 2014

Bed sizes 120 x 200 cm and 140 x 200 cm | Metal frame with beech wood slats | Nordic mattress with Soft Spring comfort, see page 160 | Legs in lacquered oak | Back frame cover included | Optional seat frame cover | Bedding box | Detachable and washable frame covers | Page 72: Shown in size 140 cm in 535 Bouclé Forest Green | Page 73: Shown in size 120 cm in 507 Elegance Burned Curry | 2-4 weeks delivery time | See all fabric options, page 163 | Scan the QR code to see additional features at our website

Aslak is part of the Multifunctionals assortment and has several options of mattress comfort and cover styles, see page 160-161



The Scandinavian Touch

Sly Wood

Design by Per Weiss 2006, 2021

Bed size 140 x 200 cm | Metal frame with Pocket Spring comfort, see page 156 | Legs in lacquered oak | Bedding box | Optional headrest | Shown in 527 Mixed Dance Natural | Shown fabrics: 2-4 weeks delivery time | Other fabric options with 13-15 weeks delivery time, see page 163 | Scan the QR code and see further features at our website

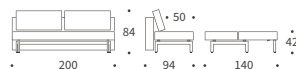

Trym

Design by Per Weiss 2014

Bed size 140 x 200 cm | Metal frame with Pocket Spring comfort, see page 156 | Legs in lacquered oak
| Detachable and washable covers | Bedding box | Optional headrest | Shown in 521 Mixed Dance
Grey | Shown fabrics: 2-4 weeks delivery time | Other fabric options with 13-15 weeks delivery time, see
page 163 | Scan the QR code to see additional features at our website

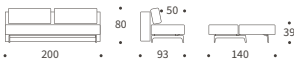

The Scandinavian Touch



Idun

Design by Per Weiss 2014

Bed size 140 x 200 cm | Metal frame with Pocket Spring comfort, see page 156 | Legs in lacquered oak | Detachable and washable covers | Bedding box | Optional headrest | Shown in 539 Bouclé Beige | Shown fabrics: 2-4 weeks delivery time | Other fabric options with 13-15 weeks delivery time, see page 163 | Scan the QR code to see additional features at our website



521 539



The Scandinavian Touch



Mimer

Design by Per Weiss 2016

Bed size 140 x 200 cm | Metal frame with beech wood slats | Nordic mattress with Spring comfort, see page 160 | Legs in lacquered oak | Back frame cover included | Optional seat frame cover | Bedding box | Detachable and washable mattress cover and frame covers | Shown in 280 Avella Sand | 2-4 weeks delivery time | See all fabric options, page 163 | Scan the QR code to see additional features at our website

Mimer is part of the Multifunctionals assortment and has several options of mattress comfort and cover styles, see page 160-161



The Scandinavian Touch



Frode & Frode with arms

Design by Per Weiss 2018

Bed size 140 x 200 cm | Metal frame with Pocket Spring Dual comfort, see page 156 | Stem legs in lacquered oak | Optional arms | Optional headrest | Bedding box | Shown combination: Page 80: Frode with arms in fabric 531 Bouclé Off White | Shown combination: Page 81: Frode in fabric 573 Vivus Dusty Blue | Shown fabrics: 2-4 weeks delivery time | Other fabric options with 13-15 weeks delivery time, see page 163 | Scan the QR code to see additional features at our website

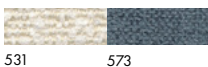
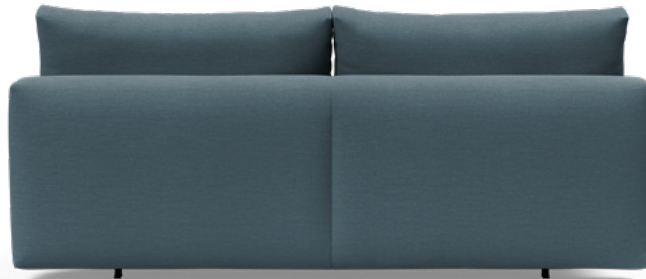

531

573



European Modernism



European Modernism

A selection of designs inspired by the revolutionary Bauhaus school's thoughts on how to create modern, functional quality furniture optimized for industrial production. The modernist furniture movement was largely driven by the enthusiasm for industrial processing of metal, and our range pays homage to this with signature metal legs.

European Modernism

Splitback Chrome with arms

Design by Per Weiss 2004

Bed size 115 x 210 cm | Chair size 115 x 90 cm | Metal frame with Pocket Spring comfort, see page 156 | Legs in chromed steel | Shown in 580 Argus Navy Blue | Shown fabrics: 2-4 weeks delivery time | Other fabric options with 13-15 weeks delivery time, see page 163 | Scan the QR code to see additional features at our website



216

507

521

525

531

580

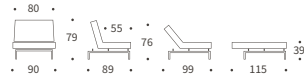
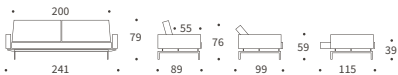

European Modernism



Cubed Alu

Design by Per Weiss, Oliver & Lukas WeissKrogh 2009, 2019

Bed sizes 90 x 200 cm, 140 x 200 cm and 160 x 200 cm | No-zag Spring with high resilient foam comfort, see page 156 | Legs in aluminium | Bedding box | Optional headrest | Shown in 140 cm in 528 Mixed Dance Blue | Shown fabrics: 2-4 weeks delivery time | Other fabric options with 6-8 weeks delivery time, see page 163 | Scan the QR code to see additional features at our website

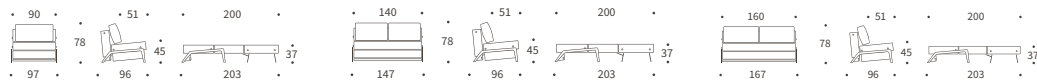

European Modernism

Cubed Chrome

Design by Per Weiss 2009

Bed sizes 90 x 200 cm, 140 x 200 cm and 160 x 200 cm | No-zag Spring with high resilient foam comfort, see page 156 | Legs in chromed steel | Bedding box | Optional headrest | Shown in 90 cm in 581 Argus Rust | Shown fabrics: 2-4 weeks delivery time | Other fabric options with 6-8 weeks delivery time, see page 163 | Scan the QR code to see additional features at our website

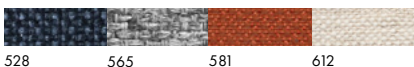
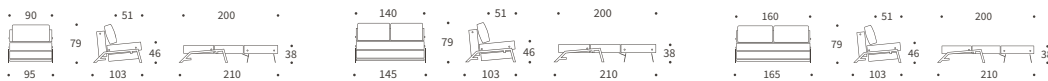



European Modernism



Cubed with arms

Design by Per Weiss 2009, 2015

Bed sizes 90 x 200 cm, 140 x 200 cm and 160 x 200 cm | No-zag Spring with high resilient foam comfort, see page 156 | Legs in matt black steel | Bedding box | Optional headrest | Shown in 160 cm in 612 Blida Sand Grey | Shown fabrics: 2-4 weeks delivery time | Other fabric options with 6-8 weeks delivery time, see page 163 | Scan the QR code to see additional features at our website

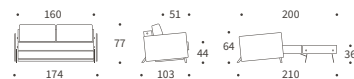
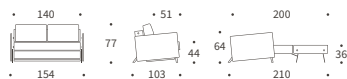

European Modernism

Zeal Straw

Design by Per Weiss 2013

Bed size 70 x 200 cm | Metal frame with Pocket Spring comfort, see page 156 | Legs in aluminium |
Shown in 581 Argus Rust | Shown fabrics: 2-4 weeks delivery time | Other fabric options with 13-15
weeks delivery time, see page 163 | Scan the QR code to see additional features at our website

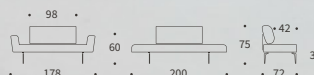
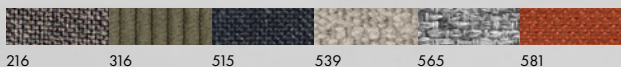

Zeal Laser

Design by Per Weiss 2013

Bed size 70 x 200 cm | Metal frame with Pocket Spring comfort, see page 156 | Legs in matt black steel | Shown in 316 Cordufine Pine Green | Shown fabrics: 2-4 weeks delivery time | Other fabric options with 13-15 weeks delivery time, see page 163 | Scan the QR code to see additional features at our website

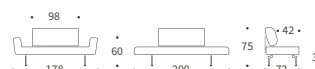

European Modernism

Ghia Chrome

Design by Per Weiss 2007

Bed size 80 x 210 cm | Metal frame with Pocket Spring comfort, see page 156 | Chrome legs in chromed steel | Shown in 551 Faunal Brown | Shown fabrics: 2-4 weeks delivery time | Other fabric options with 13-15 weeks delivery time, see page 163 | Scan the QR code to see additional features at our website

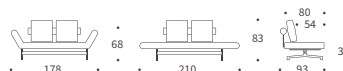

Ghia Laser

Design by Per Weiss 2007, 2016

Bed size 80 x 210 cm | Metal frame with Pocket Spring comfort, see page 156 | Laser legs matt black steel | Shown in 318 Cordufine Beige with Laser legs | Shown fabrics: 2-4 weeks delivery time | Other fabric options with 13-15 weeks delivery time, see page 163 | Scan the QR code to see additional features at our website

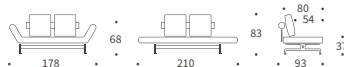

European Modernism



Supremax D.E.L.

Design by Per Weiss 2008

Bed size 155 x 200 cm | Ottoman size 65 x 65 cm | Metal frame with Excess Pocket Spring comfort, see page 156 | Legs in chromed steel | Optional headrest | Page 96: Shown in 528 Mixed Dance Blue | Page 97: Shown in 563 Twist Charcoal | Shown fabrics: 2-4 weeks delivery time | Other fabric options with 13-15 weeks delivery time, see page 163 | Scan the QR code to see additional features at our website



528 563 587

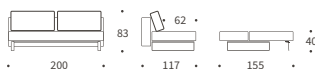

European Modernism

Cassius D.E.L.

Design by Per Weiss 2008

Bed size 155 x 200 cm | Ottoman size 65 x 65 cm | Metal frame with Excess Pocket Spring comfort, see page 156 | Legs in chromed steel | Optional headrest | Page 98: Shown in 587 Phobos Mocha | Page 99: Shown in 528 Mixed Dance Blue | Shown fabrics: 2-4 weeks delivery time | Other fabric options with 13-15 weeks delivery time, see page 163 | Scan the QR code to see additional features at our website



528 563 587

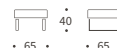
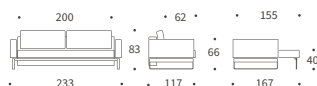



European Modernism



Minimum

Design by Peter Henriksen & Per Weiss 2003

Bed size 140 x 200 cm | Metal frame with beech wood slats | Classic comfort with Nordic Mattress, see page 160 | Legs in chromed steel | Back frame cover included | Optional seat frame cover | Bedding box | Detachable and washable covers | Shown in 351 Taura Slate Grey | 2-4 weeks delivery time | See all fabric options, page 163 | Scan the QR code to see additional features at our website

Minimum is part of the Multifunctionals assortment and has several options of mattress comfort and cover styles, see page 160-161



European Modernism



Nordham

Design by Per Weiss 2020

Bed size 140 x 200 cm | Metal frame with Pocket Spring comfort, see page 156 | Legs in brushed stainless steel | Bedding box | Optional headrest | Page 102: Shown in 528 Mixed Dance Blue | Page 103: Shown in 590 Micro Check Grey | Shown fabrics: 2-4 weeks delivery time | Other fabric options with 13-15 weeks delivery time, see page 163 | Scan the QR code to see additional features at our website

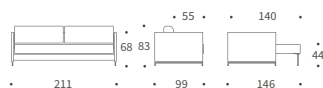
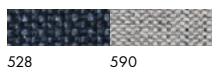
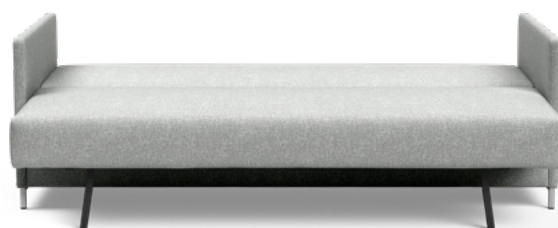

European Modernism

Long Horn D.E.L.

Design by Per Weiss, Oliver & Lukas WeissKrogh 2008, 2015

Bed size 140 x 210 cm | Chair size 115 x 85 cm | Metal frame with Excess Pocket Spring comfort, see page 156 | Legs in stainless steel and arms in walnut veneer | Optional arms | Page 104: Shown in 565 Twist Granite | Page 105: Shown in 539 Bouclé Beige with arms in walnut veneer | Shown fabric: 2-4 weeks delivery time | Other fabric options with 13-15 weeks delivery time, see page 163 | Scan the QR code to see additional features at our website



539 565

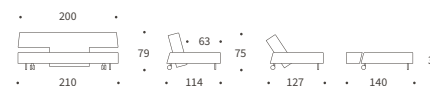
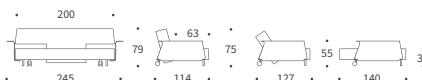



European Modernism



Luoma

Design by Per Weiss 2022

Bed size 140 x 200 cm | No-zag Spring with high resilient foam comfort, see page 156 | Legs in matt black steel | Bedding box | Optional headrest | Page 106: Shown in 300 Weda Sand | Page 107: Shown in 302 Weda Blue | Shown fabrics: 2-4 weeks delivery time | Other fabric options with 13-15 weeks delivery time, see page 163 | Scan the QR code to see additional features at our website

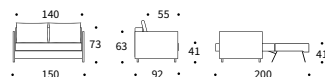

European Modernism



Malloy

Design by Per Weiss 2020

Bed size 150 x 200 cm | Ottoman size 75 x 100 cm | Metal frame with Pocket Spring Dual comfort, see page 156 | Legs in matt black steel | Bedding box | Shown in 579 Kenya Gravel | Shown fabrics: 2-4 weeks delivery time | Other fabric options with 13-15 weeks delivery time, see page 163 | Scan the QR code to see additional features at our website



533

579

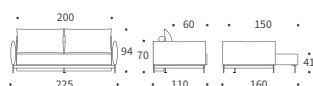

European Modernism

Junus

Design by Per Weiss 2021

Bed size 140 x 200 cm | Metal frame with beech wood slats | Spring comfort with detachable Sharp cover, see page 160 | Legs in matt black steel | Back frame cover included | Optional seat frame cover | Bedding box | Detachable and washable mattress cover and frame covers | Shown in 301 Weda Rust | 2-4 weeks delivery time | See all fabric options, page 163 | Scan the QR code to see additional features at our website

Junus is part of the Multifunctionals assortment and has several options of mattress comfort and cover styles, see page 160-161

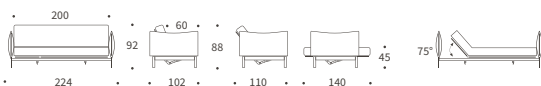



European Modernism



Sigmund Indu

Design by Per Weiss 2016

Bed sizes 80 / 160 x 200 cm | Pocket Spring comfort, see page 157 | Indu legs in matt black steel |
 Page 112: Shown in 595 Corduroy Burnt Orange | Page 113: Shown in 537 Bouclé Blue | Shown
 fabrics: 2-4 weeks delivery time | Other fabric options with 6-8 weeks delivery time, see page 163 |
 Scan the QR code to see additional features at our website

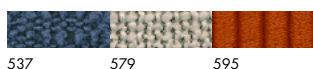

European Modernism

A sophisticated detail that makes a difference



Sigga X

Design by Per Weiss 2022

Bed size 137 x 190 cm | Metal frame with Pocket Spring comfort, see page 156 | Legs in matt black steel | Bedding box | Only available in shown fabrics 300 Weda Sand and 302 Weda Blue | Delivery time: 2-4 weeks | Scan the QR code to see additional features at our website



300

302

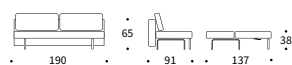

190

65

91

137

38



European Modernism



Bragi

Design by Emil Højfeldt & Per Weiss 2015

Bed size 140 x 200 cm | Metal frame with Pocket Spring comfort, see page 156 | Legs in matt black steel | Reversible lounger | Available with side table or upholstered arms | Optional headrest | Shown in 217 Flashtex Light Grey | Shown fabric: 2-4 weeks delivery time | Other fabric options with 13-15 weeks delivery time, see page 163 | Scan the QR code to see additional features at our website



217

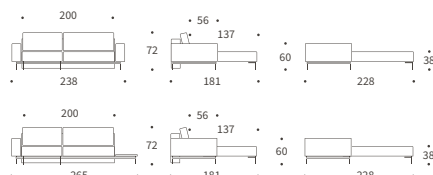

European Modernism



Sly

Design by Per Weiss 2006

Bed size 140 x 200 cm | Metal frame with Pocket Spring comfort, see page 156 | Legs in matt black steel | Bedding box | Optional headrest | Shown in 563 Twist Charcoal | Shown fabrics: 2-4 weeks delivery time | Other fabric options with 13-15 weeks delivery time, see page 163 | Scan the QR code to see additional features at our website

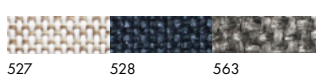

European Modernism



Fraction

Design by Per Weiss 2008

Bed sizes 120 x 200 cm and 140 x 200 cm | Metal frame with beech wood slats | Nordic mattress with Soft Spring comfort, see page 160 | Legs in matt black steel | Back frame cover included | Optional seat frame cover | Bedding box | Detachable and washable frame covers | Shown in size 120 cm in 537 Bouclé Blue | 2-4 weeks delivery time | See all fabric options, page 163 | Scan the QR code to see additional features at our website

Fraction is part of the Multifunctionals assortment and has several options of mattress comfort and cover styles, see page 160-161



European Modernism



Narvi

Design by Per Weiss 2018

Bed size 140 x 200 cm | Metal frame with Pocket Spring comfort, see page 156 | Arms in cane web black lacquered oak | Detachable and washable covers | Bedding box | Optional headrest | Shown in 539 Bouclé Beige | Shown fabrics: 2-4 weeks delivery time | Other fabric options with 13-15 weeks delivery time, see page 163 | Scan the QR code to see additional features at our website

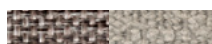

521

539

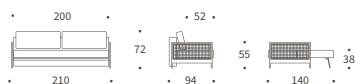

European Modernism



Bifrost D.E.L.

Design by Per Weiss 2008

Bed size 155 x 200 cm | Ottoman size 65 x 65 cm | Metal frame with Excess Pocket Spring comfort, see page 156 | Arms and legs in black stained wood | Optional headrest | Shown in 587 Phobos Mocha | Shown fabrics: 2-4 weeks delivery time | Other fabric options with 13-15 weeks delivery time, see page 163 | Scan the QR code to see additional features at our website

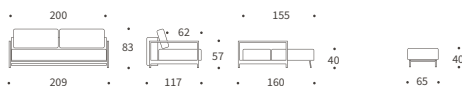

Mid-Century Modern



Mid-Century Modern

A selection of designs with reference to international Mid-Century Modern. The archetypal stiletto leg has become the signature element of the assortment.

Mid-Century Modern

Unfurl Lounger

Design by Andreas Lund, Flemming Højfeldt & Per Weiss 2017

Bed size 140 x 200 cm | Metal frame with Pocket Spring comfort, see page 156 | Styletto legs in dark lacquered oak | Shown in 594 Corduroy Ivory | Shown fabrics: 2-4 weeks delivery time | Other fabric options with 13-15 weeks delivery time, see page 163 | Scan the QR code to see additional features at our website





Mid-Century Modern

Unfurl

Design by Andreas Lund, Flemming Højfeldt & Per Weiss 2004

Bed size 120 x 200 cm | Metal frame with Pocket Spring comfort, see page 156 | Styletto legs in dark lacquered oak | Shown in 529 Bouclé Charcoal | Shown fabrics: 2-4 weeks delivery time | Other fabric options with 13-15 weeks delivery time, see page 163 | Scan the QR code to see additional features at our website



217

529

536



Unfurl Special Teddy

Design by Andreas Lund, Flemming Højfeldt & Per Weiss 2004

Bed size 120 x 200 cm | Metal frame with Pocket Spring comfort, see page 156 | Styletto legs in dark lacquered oak | This is a limited edition fabric, only available for Unfurl: 2-4 weeks delivery time | Scan the QR code to see additional features at our website



Mid-Century Modern

Splitback Dark Styletto with arms

Design by Per Weiss 2004, 2014

Bed size 115 x 210 cm | Chair size 115 x 90 cm | Metal frame with Pocket Spring comfort, see page 156 | Legs shown in dark lacquered oak | Shown with Sharp arms in 507 Elegance Burned Curry | Shown fabrics: 2-4 weeks delivery time | Other fabric options with 13-15 weeks delivery time, see page 163 | Scan the QR code to see additional features at our website

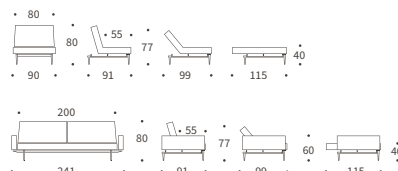



Mid-Century Modern

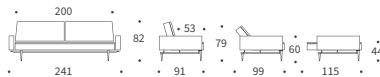
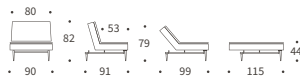
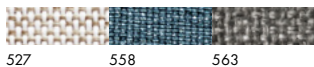

Dublexo Dark Styletto with arms

Design by Per Weiss 2011

Bed size 115 x 210 cm | Chair size 115 x 90 cm | Metal frame with Pocket Spring Dual comfort, see page 156 | Legs shown in dark lacquered oak | Shown with Round arms in 527 Mixed Dance Natural | Shown fabrics: 2-4 weeks delivery time | Other fabric options with 13-15 weeks delivery time, see page 163 | Scan the QR code to see additional features at our website



Mid-Century Modern

Zeal Styletto

Design by Per Weiss 2013

Bed size 70 x 200 cm | Metal frame with Pocket Spring comfort, see page 156 | Styletto legs in dark lacquered oak | Shown in 539 Bouclé Beige | Shown fabrics: 2-4 weeks delivery time | Other fabric options with 13-15 weeks delivery time, see page 163 | Scan the QR code to see additional features at our website

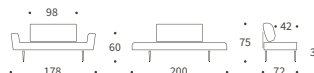



Mid-Century Modern

Recast Dark Styletto

Design by Per Weiss 2011, 2015

Bed size 140 x 200 cm | Ottoman size 66 x 66 cm | Metal frame with Pocket Spring comfort, see page 156 | Styletto legs in dark lacquered oak | Optional arms in walnut veneer | Bedding box | Optional headrest | Page 138: Shown in 536 Bouclé Ochre | Page 139: Shown in 357 Tarua Off White with arms in walnut veneer | Shown fabrics: 2-4 weeks delivery time | Other fabric options with 13-15 weeks delivery time, see page 163 | Scan the QR code to see additional features at our website

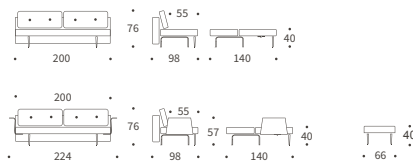



Mid-Century Modern



Recast Light Styletto

Design by Per Weiss 2011, 2015

Bed size 140 x 200 cm | Ottoman size 66 x 66 cm | Metal frame with Pocket Spring comfort, see page 156 | Styletto legs in lacquered oak | Bedding box | Optional headrest | Shown in 590 Micro Check Grey | Shown fabric: 2-4 weeks delivery time | Other fabric options with 13-15 weeks delivery time, see page 163 | Scan the QR code to see additional features at our website



590

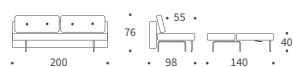

Mid-Century Modern



Conlix

Design by Per Weiss 2020

Bed size 140 x 200 cm | Metal frame with Pocket Spring comfort, see page 156 | Trumpet legs in lacquered oak | Detachable and washable cover | Bedding box | Optional headrest | Shown in 531 Bouclé Off White | Shown fabrics: 2-4 weeks delivery time | Other fabric options with 13-15 weeks delivery time, see page 163 | Scan the QR code and see further features at our website

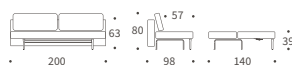
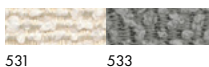

Mid-Century Modern

Vanadis

Design by Per Weiss 2018

Bed size 80 x 200 cm | Frame in lacquered oak with Bonell Spring comfort, see Page 157 | Storage | Legs in lacquered oak | Optional metal back support | Shown in 563 Twist Charcoal | Shown fabric: 2-4 weeks delivery time | Other fabric options with 6-8 weeks delivery time, see page 163 | Scan the QR code to see additional features at our website

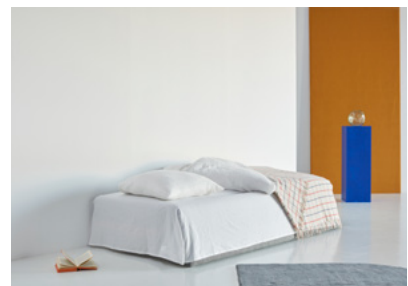
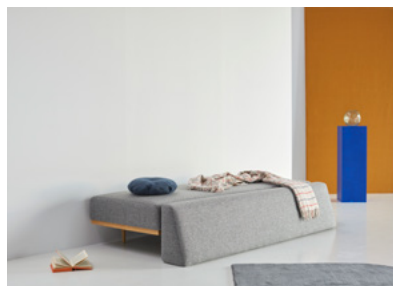
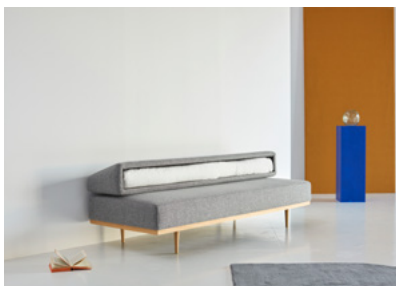

563

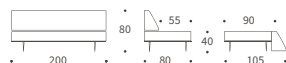



Mid-Century Modern



Colpus

Design by Per Weiss 2014

Bed size 140 x 200 cm | Metal frame with beech wood slats | Soft Spring comfort with Nordic mattress, see page 160 | Legs in lacquered or black lacquered oak | Back frame cover included | Optional seat frame cover | Bedding box | Detachable and washable frame covers | Shown in 531 Bouclé Off White with legs in lacquered oak | 2-4 weeks delivery time | See all fabric options, page 163 | Scan the QR code to see additional features at our website

Colpus is part of the Multifunctionals assortment and has several options of mattress comfort and cover styles, see page 160-161



Also available with
black lacquered
oak legs



There is an intention behind every design

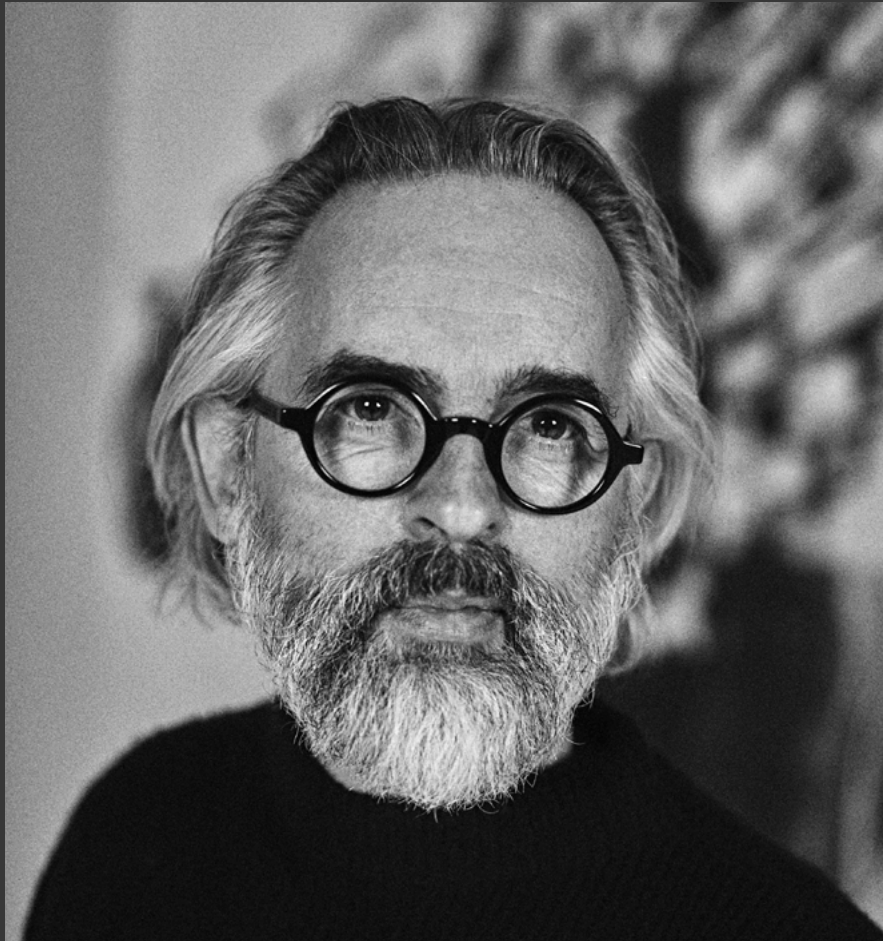

Per Weiss

Chief Design Officer
Innovation Living Design Office

The Danish designer Per Weiss is the Chief Design Officer at Innovation Living. He has been part of Innovation Living since 1989 and is the driving force behind the constant creative development of the collections.

Based on the Scandinavian design tradition, Per is constantly striving to create durable designs that reflect zeitgeist - attractive designs that will make a positive difference in everyday life.



01



02



03



04



05

01. Emil Højfeldt, Product- & Production Development Manager
 02. Oliver & Lukas WeissKrogh, Studio WeissKrogh
 03. Flemming Højfeldt, Founder of Innovation Living™
 04. Jesper Elg, Owner of v1 Gallery Copenhagen
 05. Andreas Lund, Industrial Designer
 06. Peter Henriksen, Industrial Designer



06

Chairs & Floorlife



Vikko Chair & Vikko Chair with arms

Design by Emil Højfeldt & Per Weiss 2018, 2020

Size: 68 x 62 cm | Seat Height: 37 cm | Legs in matt black steel | Page 150 shown with arms in 537 Bouclé Blue | Page 151 shown in 535 Bouclé Forest Green | Shown fabrics: 2-4 weeks delivery time | Other fabric options with 6-8 weeks delivery time, see page 163

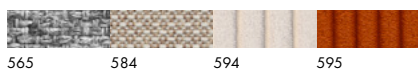
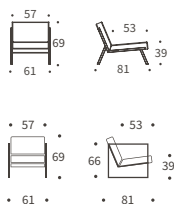

Soft Peak Bean Bag

Design by Innovation Living Design Office 2015

Size: 105-135-80 cm | Detachable and washable cover | Volume: Inside 300 litres EPS Beads | Shown in 594 Corduroy Ivory | 2-4 weeks delivery time | The detachable cover makes it possible to renew the bean bag. Can also be refilled. | See all fabric options, page 163

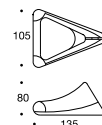

Chairs & Floorlife



Butt Bean Bag

Design by Jesper Elg 2002

Size: 45 x H50 cm | Detachable and washable cover | Volume: Inside 100 litres EPS Beads | Shown in 536 Bouclé Ochre | 2-4 weeks delivery time | The detachable cover makes it possible to renew the bean bag. Can also be refilled | See all fabric options, page 163

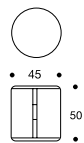

Pauke Poufs 50 & 62 cm

Design by Innovation Living Design Office

Sizes: Ø50 x 20 cm and Ø62 x 40 cm | Recycled foam | Detachable and washable cover | Shown in 536 Bouclé Ochre, 537 Bouclé Blue and 535 Bouclé Forest Green | Shown fabrics: 2-4 weeks delivery time | Other fabric options with 4-6 weeks delivery time, see page 163



Triangular Pouf

Design by Innovation Living Design Office

Size: W 60 x H 37 cm | Recycled foam | Detachable and washable cover | Shown in 536 Bouclé Ochre | Shown fabrics: 2-4 weeks delivery time | Other fabric options with 6-8 weeks delivery time, see page 163





Dapper Cushions

Sizes: 50 x 50 cm, 65 x 65 cm, 40 x 60 cm and 50 x 80 cm | Detachable and washable cover | Feather mix inside | The detachable cover makes it possible to renew the cushion | See all fabric options, page 163

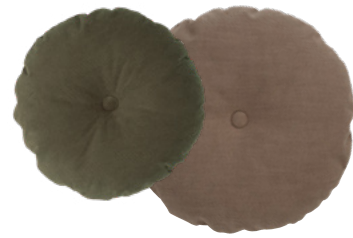

Circle Cushions

Sizes: Ø 40 cm and Ø 45 cm | Button on both sides | Polyester fill inside | See all fabric options, page 163



Ellipse Cushions

Size: 55 x 25 x 13 cm | Detachable and washable cover | Feather mix inside | The detachable cover makes it possible to renew the cushion | See all fabric options, page 163



Roll Cushions

Size: 55 x Ø 25 cm | Detachable and washable cover | Feather mix inside | The detachable cover makes it possible to renew the cushion | See all fabric options, page 163



Square Cushions

Size: 50 x 50 x 11 cm | Detachable and washable cover | Feather mix inside | The detachable cover makes it possible to renew the cushion | Recommended for Rollo daybed | See all fabric options, page 163

Headrest

Size: 25 x 60 cm | Detachable and washable cover | Inside is a foam core surrounded by a layer of fiberfill | The detachable cover makes it possible to renew the headrest | See all fabric options, page 163

Adjustable headrest available for: Bifrost, Bragi, Cassius, Conlix, Cosial, Cubed, Eilis, Eluma, Frode, Idun, Luoma, Merga, Narvi, Newilla, Newilla with lounger, Nordham, Osvald, Pyxis, Recast, Sly, Supremax, Tripi and Trym



Coffee Tables

Nordic Tables

Design by Emil Højfeldt & Per Weiss



Combine table tops with Nordic legs in lacquered oak, see options below.

Small

Top in lacquered oak veneer
Ø 35 cm | Legs 32,5 cm
Top in black stained oak veneer
Ø 35 cm | Legs 32,5 cm

Medium

Top in lacquered oak veneer
Ø 45 cm | Legs 32,5 cm
Top in black stained oak veneer
Ø 45 cm | Legs 32,5 cm

Large

Top in lacquered oak veneer
Ø 70 cm | Legs 40 cm
Top in black stained oak veneer
Ø 70 cm | Legs 40 cm

Grids Tables

Design by Per Weiss



Combine table tops with Grid legs in matt black steel, see options below.

Small

Top in lacquered oak veneer
Ø 35 cm | Legs 25 cm
Top in black stained oak veneer
Ø 35 cm | Legs 25 cm

Medium

Top in lacquered oak veneer
Ø 45 cm | Legs 32,5 cm
Top in black stained oak veneer
Ø 45 cm | Legs 32,5 cm

Large

Top in lacquered oak veneer
Ø 70 cm | Legs 40 cm
Top in black stained oak veneer
Ø 70 cm | Legs 40 cm

Stylo Tables

Design by Emil Højfeldt & Per Weiss



Combine black table tops with Stylo legs in dark lacquered oak, see options below.

Small

Top in black stained oak veneer
Ø 35 cm | Legs 32,5 cm

Medium

Top in black stained oak veneer
Ø 45 cm | Legs 32,5 cm

Large

Top in black stained oak veneer
Ø 70 cm | Legs 40 cm

*All table tops are available separately and can be used as a tray.

Marble Tables

Design by Emil Højfeldt & Per Weiss



Combine Marble table tops with Laser legs in black steel, see options below.

Small

Top in Ø 35 cm | Legs 32,5 cm

Medium

Top in Ø 45 cm | Legs 32,5 cm

Large

Top in Ø 70 cm | Legs 40 cm

Laser Tables

Design by Per Weiss



Combine table tops with Laser legs in black steel, see options below.

Small

Top in lacquered oak veneer
Ø 35 cm | Legs 32,5 cm
Top in black stained oak veneer
Ø 35 cm | Legs 32,5 cm

Medium

Top in lacquered oak veneer
Ø 45 cm | Legs 32,5 cm
Top in black stained oak veneer
Ø 45 cm | Legs 32,5 cm

Large

Top in lacquered oak veneer
Ø 70 cm | Legs 40 cm
Top in black stained oak veneer
Ø 70 cm | Legs 40 cm

Kiffa Table

Design by Emil Højfeldt 2017



The Kiffa table is a flexible and easily height adjustable table for any purpose.

Size Ø 45 cm | Height 41 - 70 cm | Table base: Matt black steel | Top in lacquered oak veneer or black stained oak veneer.

Storage Table

Design by Emil Højfeldt & Per Weiss 2016



Storage: 110 litres | Size: Ø 70 cm and H 43 cm | Table Top: 70 cm, black stained oak veneer or lacquered oak veneer | The table has a movable table top and a large storage compartment | Shown fabric: 2-4 weeks delivery time | Other fabric options with 4-6 weeks delivery time, see page 163



Comfort

Pocket Spring

The individual pockets in these models ensure that pressure is applied to each individual spring for optimal support – in seating as well as sleeping position. The high resilient foam casing contributes to a breathable mattress while providing a soft top support.

The following models have this comfort:

Bragi, Conlix, Cosial, Eilis, Eluma Deluxe Button, Ghia, Idun, Narvi, Nolis, Nordham, Pascala, Recast, Sigga X, Splitback, Sly, Sly Wood, Trym, Unfurl, Unfurl Lounger and Zeal.

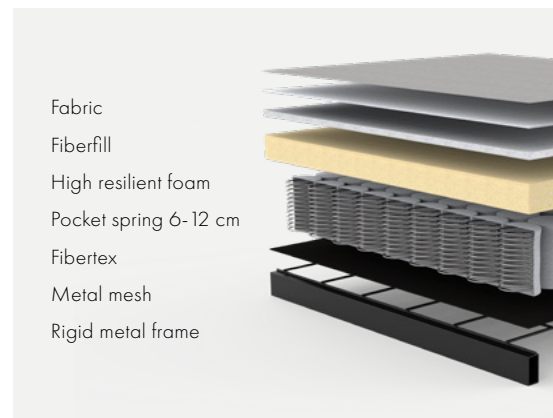

Pocket Spring Dual

The Pocket Spring Dual comfort share the general composition of the Pocket Spring models apart from the extra layer of hyper soft foam that gives these sofa beds an extra soft feel. This extra layer of luxury provides a soft seating and sleeping comfort.

The following models have this comfort:

Cornila, Dublexo, Frode, Malloy, Malloy Wood, Osvald and Tripi.

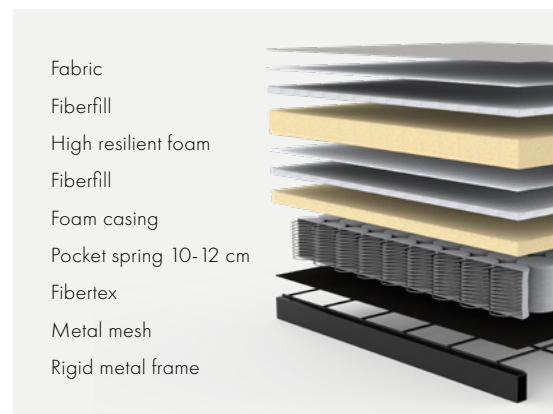

Excess Pocket Spring

The higher coils in the Excess Pocket Spring models provide a softer sofa comfort. In combination with the core foam casing, the Excess mattress has higher absorption of pressure on each spring for a more comfortable sleep.

The following models have this comfort:

Bifrost D.E.L., Cassius D.E.L., Long Horn D.E.L., Pyxis D.E.L., Supremax D.E.L., Vogan, Vogan Lounger and Yonata.

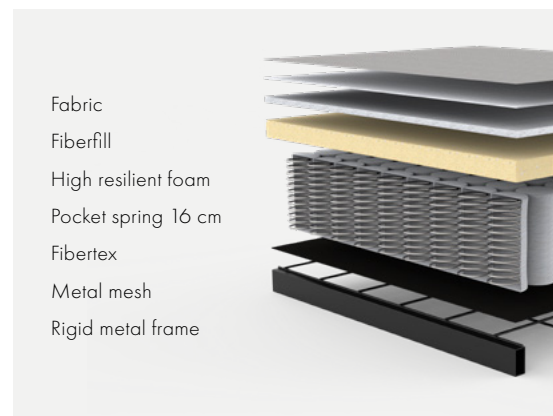

No-zag Spring

The no-zag springs and the thick layer of high resilient foam provide an even and soft seating as well as sleeping experience.

The following models have this comfort:

Cubed, Luoma and Olan.

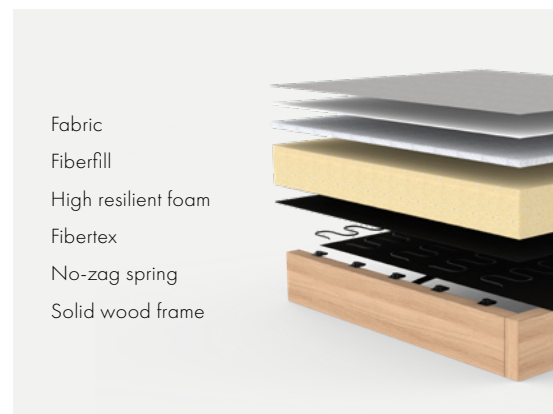

No-zag and Pocket Spring

The combination of no-zag and pocket springs with a hyper soft foam on top create a unique softness in seating as well as sleeping position. The use of no-zag contributes to an extra layer of elasticity and allows the mattress to breathe.

The following models have this comfort:

Merga, Newilla and Newilla with lounger.



Bonell Spring

The Bonell Spring mattress is characterised by the use of strong, connected springs topped with a layer of high resilient foam. This spring type distributes the pressure from your body on a larger area to create an even, yet elastic support.

The following model has this comfort:

Vanadis.

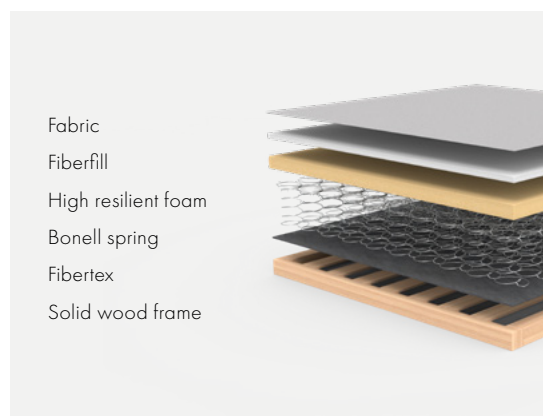

Sigmund

Pocket Spring mattresses ensure that pressure is applied to each spring separately. The result is a mattress that supports individual parts of your body better. The springs are surrounded by layers of high resilient foam providing a soft top support – whether for playing, sitting, or sleeping. Pocket Split mattresses consist of two separate mattresses that can be used separate or in combination.

The following model has this comfort:

Sigmund.

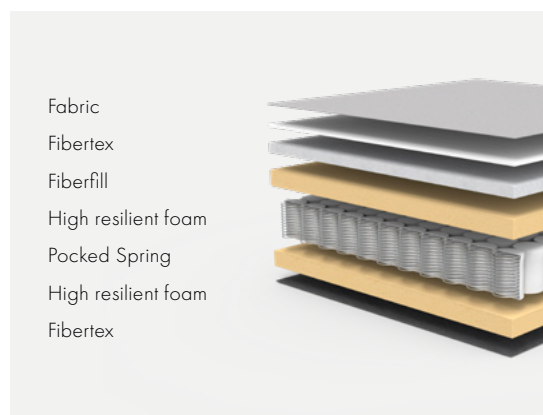

Comfort

5-zone Multi-Pocket Spring

The breathable Multi-Pocket Spring mattress - designed for comfortable sleep with as many as 650 springs per square meter and 5 comfort zones to support the individual parts of your body. Furthermore, the cover is removable and can be washed at 60 degrees Celsius.

Available for:
Eivor and Killian.

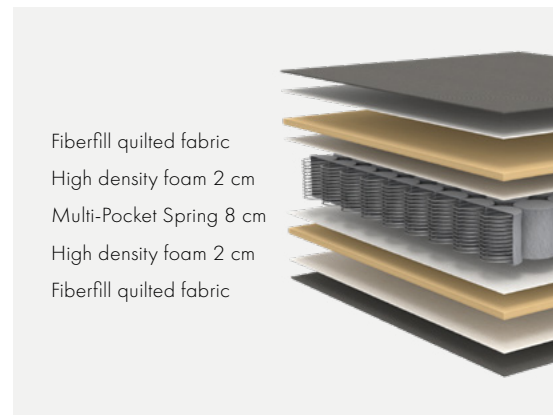

Dual Memory

The Dual Memory mattress features two comforts in one as the mattress is reversible with one side consisting of an 8 cm high density foam whilst the other side consists of 4 cm OEKO-TEX® certified memory foam. Whether you prefer soft or firm comfort this mattress offers both. Furthermore, the cover is removable and can be washed at 60 degrees Celsius.

Available for:
Eivor and Killian.

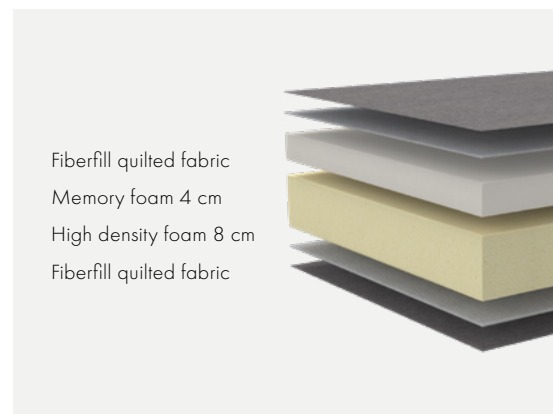

Puri

A core of high resilient OEKO-TEX® foam surrounded by soft layers of fiberfill creates a firm mattress suitable for comfortable seating and sleeping.

The following model has this comfort:
Puri.

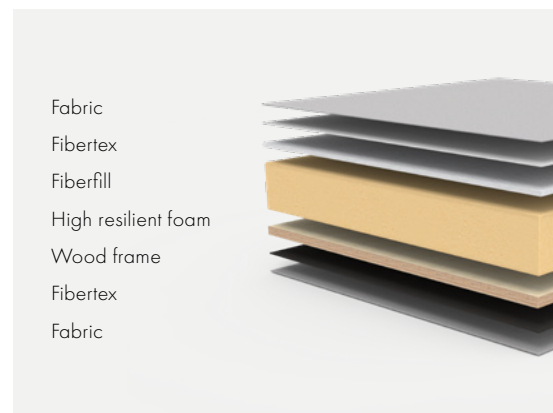

Inno Toppers

80 / 90 / 120 / 140 / 150 / 160 / 180 x 200 cm.

A 5 cm durable and reversible top mattress with a core of hyper soft foam that provides an even and supportive sleeping surface on all adjustable sofa beds. The cover is 100% polyester which is breathable, removable and machine-washable at 60 degrees Celsius.

The top mattress comes with a bag for storage when not in use. The bag helps minimise the volume of the topper for better storage.



Mattress Pads

80 / 90 / 120 / 140 / 150 / 160 x 200 cm.

A mattress pad provides a little extra cushioning and an added layer of protection for your mattress. They can be removed and machine-washed at 60 degree Celsius. The fabric is OEKO-TEX® standard 100 certified.

Available for most mattresses.

Multifunctionals

Customize your sofa

- 01 Choose frame
- 02 Select mattress type
- 03 Choose between fixed or removable cover
- 04 Select the styling of your cover
- 05 Select frame cover for the seat
- 06 Choose fabric

The frames

- Aslak**, see page 72
- Balder**, see page 64
- Colpus**, see page 146
- Fraction**, see page 120
- Junus**, see page 110
- Mimer**, see page 78
- Minimum**, see page 100

The mattresses:

Classic

Firmness rating: Firm

Mattress sizes: 120 / 140 x 200 cm.

Made from recycled foam, the Classic mattress is durable and provides a high degree of support for a comfortable sleep. Our high density foam provides strong motion isolation, making it easy to share the mattress. Choose our Classic mattress for a firm comfort.



Spring

Firmness rating: Soft

Mattress sizes: 120 / 140 x 200 cm.

The spring mattress is characterized by the soft comfort combined with effective pressure relief. Furthermore, the combination of fiberfill, a thin layer of foam, and the pocket springs ensure that the mattress is breathable and able to conduct moisture and heat away at night.



Soft Spring

Firmness rating: Extra soft

Mattress sizes: 120 / 140 x 200 cm.

The Soft Spring mattress offers a unique comfort achieved through the combination of pocket springs and the built in topper of hyper soft foam. Choose our Soft Spring mattress for an extra soft comfort.



Latex

Firmness rating: Medium

Mattress size: 140 x 200 cm.

A breathable natural core of high quality OEKO-TEX® latex ensures a durable mattress that adjusts to your body. Latex sleeps cooler than foam and reacts instantly to your every move. As Latex is derived from a sustainable resource, it is the eco-friendly choice. Choose our Latex mattress for a medium comfort.



Non-detachable covers

Nordic Mattress

This is the standard mattress look with pull downs. You decide the textile you like, and should you later happen to change your mind about style or color, you can choose between the two detachable cover options we offer.

Available for all mattresses on page 160.



Detachable covers

Nordic Cover

This cover has a sleek, rounded surface with stylings in each of the corners of the mattress. It covers up your entire mattress, giving you the option of choosing a different color.

Should you want to change the look, simply buy a new cover instead of a new mattress.

Available for all mattresses on page 160.



Sharp Plus Cover

This cover has a sleek surface with stylings across the edges of the mattress. It covers up your entire mattress, giving you the option of choosing a different color. Should you want to change the look, simply buy a new cover instead of a new mattress. Available for all mattresses on page 160.



Patchwork Cover

The Patchwork cover is a collection of limited edition striped patchwork covers made from excess fabrics. Each textile combination has a limited number of covers based on remaining stock of textile. It covers up your entire mattress, allowing for changes in personal preferences and future updates. The Patchwork covers are washable at 30 degrees Celcius and available for all 140 x 200 mattresses.



Frame covers

A back frame cover is always included. If you prefer the full cover look, a seat frame cover can be purchased.

Back frame cover (always included)

Front seat cover (optional)



Fabric Specifications

We place high value on ensuring that our fabrics all match the high quality of the design as well as durability of our sofa beds. All fabrics are enhanced with additional backing for extended life time and undergo rigid testing to meet the high standards we impose on our designs and production. In accordance with our Planet Promise all our fabrics are OEKO-TEX® certified.

For detailed fabric information please scan the QR code.



Name	Composition	Color fastness to light (scale 1-5)	Color fastness to rubbing (scale 1-5)	Martindale	OEKO-TEX®	Machine washable	Water repellent
Argus	100 % Recycled Polyester	4-5	4-5	67.000	•	•	
Avella	100% Polyester	5	4-5	85.000	•	•	
Bouclé	55% Recycled polyester / 45% Polyester	5	4-5	27.000	•	•	
Blida	80 % Polyester / 20 % Linen	4-5	4-5	100.000	•	•	
Cordufine	85 % Polyester / 15 % Polyamide	4-5	5	100.000	•	•	•
Corduroy	100% Polyester	4-5	4	100.000	•	•	
Elegance	100 % Polyester	4-5	4-5	60.000	•	•	•
Faunal	80 % Polyester / 17,5% Leather / 2,5 % Polyurethane	4-5	4	56.000	•		
Flashtex	100 % Polyester	4-5	4	100.000	•	•	•
Kenya	100 % Polyester	4-5	4-5	100.000	•	•	
Micro Check	100 % Polyester	4-5	4-5	27.000	•	•	
Mixed Dance	100 % Polyester	4-5	5	85.500	•	•	
Nist	96 % Polyester / 4 % Linen	4-5	5	100.000	•	•	
Phobos	100 % Polyester	4-5	4-5	100.000	•	•	
Soft	100 % Polyester	4-5	5	100.000	•	•	
Taura	96 % Polyester / 4 % Acrylic	5	4-5	45.000	•	•	
Twist	100 % Polyester	4-5	5	36.000	•	•	
Weda	100 % Polyester	4-5	4-5	100.000	•	•	
Vivus	100 % Recycled Polyester	4-5	4-5	78.000	•	•	

Cleaning advisory

Fabrics: Machine washable at 30 degrees Celcius if the cover can be removed.

Leather looks: Wipe with a moist cloth, do not dry clean.

Please visit innovationliving.com for further information or scan the QR code below.



Please note that the printed presentation of the fabric texture and colors may vary from the actual fabric.



216
Flashtex, Dark Grey

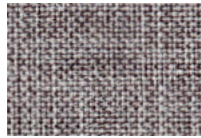

217
Flashtex, Light Grey

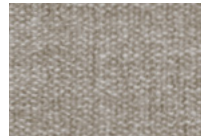

280
Avella, Sand

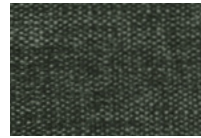

281
Avella, Pine Green

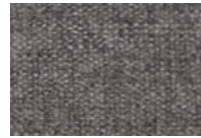

282
Avella, Warm Grey



300
Weda, Sand



301
Weda, Rust

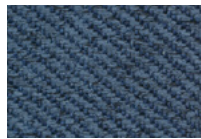

302
Weda, Blue



316
Cordufine, Pine Green



318
Cordufine, Beige

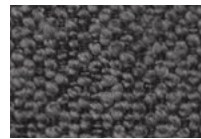

350
Taura, Deep Grey

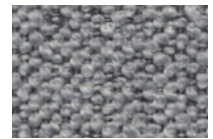

351
Taura, Slate Grey

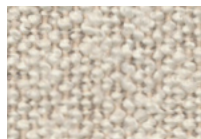

357
Taura, Off White

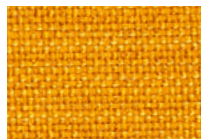

507
Elegance, Burned Curry



515
Nist, Blue



518
Elegance, Green



521
Mixed Dance, Grey

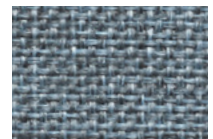

525
Mixed Dance, Light Blue



527
Mixed Dance, Natural

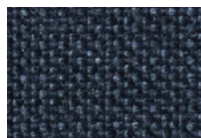

528
Mixed Dance, Blue

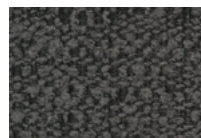

529
Bouclé, Charcoal

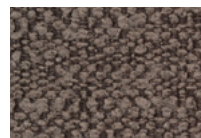

530
Bouclé, Taupe

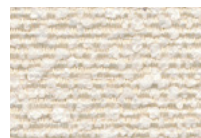

531
Bouclé, Off White



533
Bouclé, Ash Grey

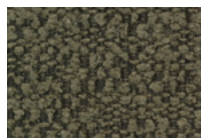

535
Bouclé, Forest Green

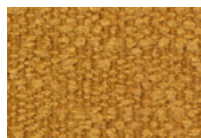

536
Bouclé, Ochre



537
Bouclé, Blue

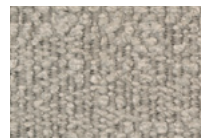

539
Bouclé, Beige

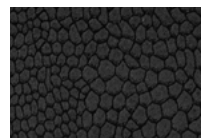

550
Faunal, Black



551
Faunal, Brown

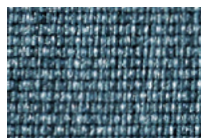

558
Soft, Indigo



563
Twist, Charcoal



565
Twist, Granite

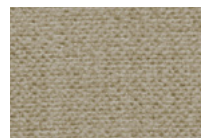

571
Vivus, Dusty Sand



573
Vivus, Dusty Blue

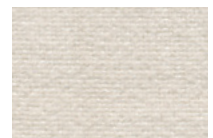

574
Vivus, Dusty Off White

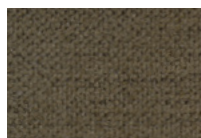

575
Vivus, Dusty Olive

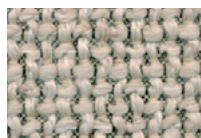

579
Kenya, Gravel



580
Argus, Navy Blue



581
Argus, Rust

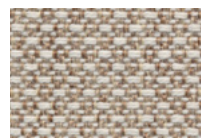

584
Argus, Natural

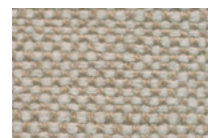

586
Phobos, Latte

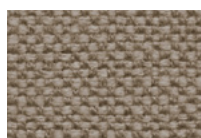

587
Phobos, Mocha

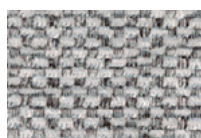

590
Micro Check, Grey

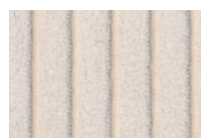

594
Corduroy, Ivory

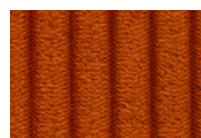

595
Corduroy, Burnt Orange



612
Blida, Sand Grey

Expand Your Living Space In Style

Follow us on

[instagram.com/innovationliving](https://www.instagram.com/innovationliving)
[facebook.com/innovationliving](https://www.facebook.com/innovationliving)
[linkedin.com/company/innovation-living](https://www.linkedin.com/company/innovation-living)
[pinterest.com/innovationtm](https://www.pinterest.com/innovationtm)

www.innovationliving.com

